





Doctor:	_____
Address:	_____
Phone No.:	_____
Dealer:	_____
Address:	_____

NOTICE

 This information is not intended to replace the information found in the **User Manual**. Refer to the **User Manual** for full installation, safety and precautions.

 **ATTENTION:** It is recommended that this equipment be installed by a licensed electrical/plumbing contractor only. **All installations must conform to local and national codes.**

EQUIPMENT ROOM LAYOUT (VACUUM WITH 15-GALLON TANK STACKED)

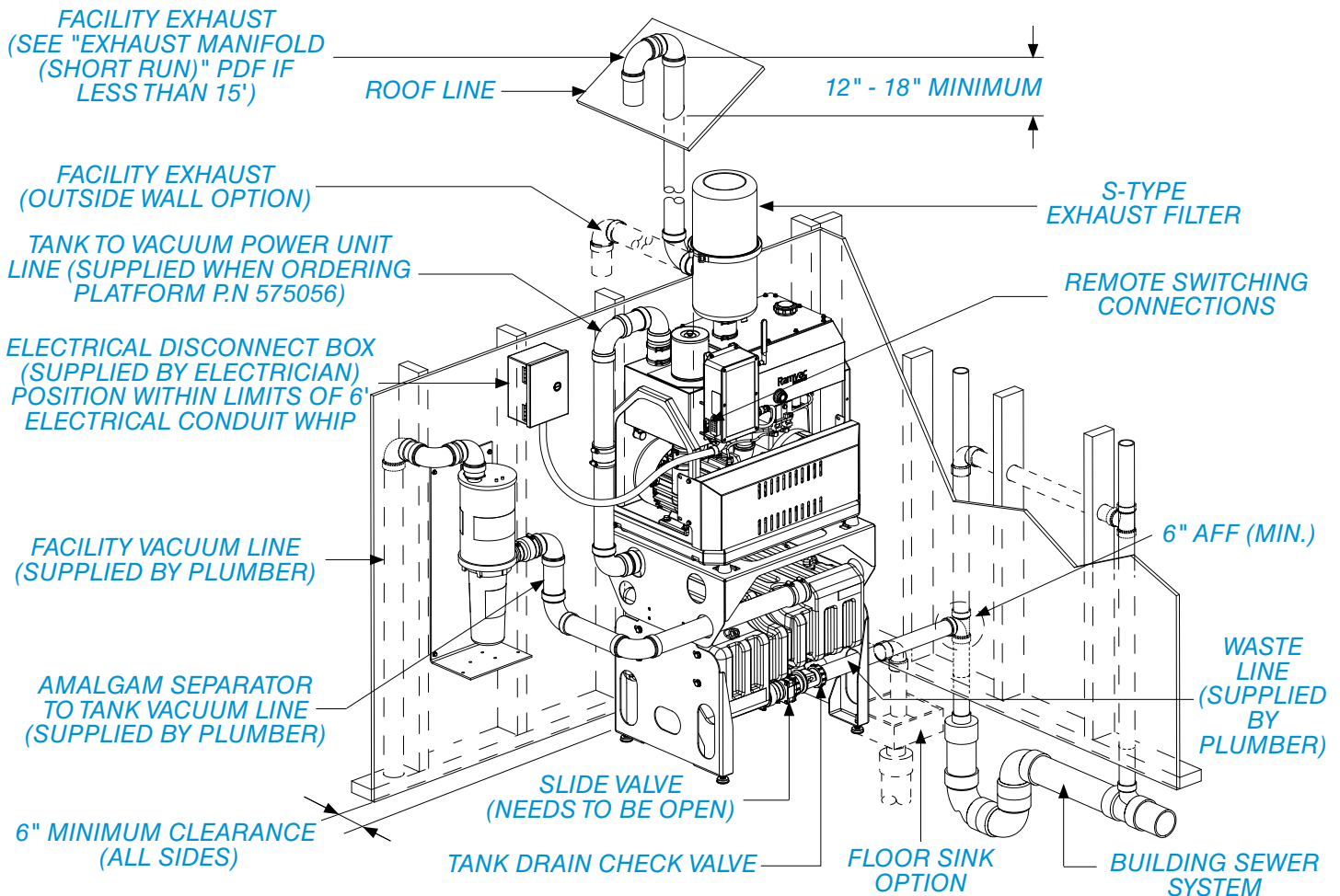

PLUMBING

FACILITY EXHAUST LINES

- 2" schedule 80 CPVC, or metal (not tar coated) with DWV fittings or equivalent. (Option: schedule 40 PVC or equivalent after first 10' of run).
- Slope: All horizontal lines toward the vacuum unit, a standard plumbing slope.
- Minimum exhaust length = 15' from Ramvac® pump to outside end. See “**Exhaust Manifold (Short Run)**” PDF if less than 15'.
- Run dedicated exhaust line for each Ramvac unit installed.
- Do not connect to plumbing vents.
- Lines must be installed to prevent condensation.
- Turn outside end down toward ground and screen to prevent entry of water, debris and creatures. Locate to prevent exhaust from entering building.

FACILITY VACUUM LINES FROM OPERATORIES

- 2" (or larger) schedule 40 PVC with DWV fittings or equivalent.
- Minimum slope 1/4" per 10'.

TANK TO VACUUM POWER UNIT LINE & AMALGAM SEPARATOR TO TANK VACUUM LINE

- 2" schedule 40 PVC with DWV fittings or equivalent.
- Use new, clean pipe to connect tank to vacuum power unit and amalgam separator to tank vacuum line. DO NOT reuse old or existing pipe.

TANK DRAIN LINE

Waste pipe, slide valve and drain check valve:

- 1½" schedule 40 PVC with DWV fittings.
- Minimum slope 1/4" per 10'.
- Use only Ramvac supplied 1½" drain check valve.
- Drain into building sewer system.

PREINSTALLATION GUIDE



PLACEMENT

- Equipment will release 2,673 BTU per hour into room. Ventilation required for room to remain between 32°F to 104°F (0°C to 40°C). Additional forced air and HVAC must be used if ambient temperatures do not fall into this range.
- Protect from water; controls and motor are NOT waterproof.
- Allow 6" minimum clearance on all sides for all units.
- If unit is placed in an area adjacent to office space, sound eliminating techniques should be considered for the unit.

ELECTRICAL

HIGH VOLTAGE

- Install a dedicated electrical circuit of sufficient capacity (see [SPECIFICATIONS & SITE REQUIREMENTS](#) table).
- Any means provided to isolate this device from the supply mains shall isolate all poles simultaneously. The disconnection means and overcurrent protection are to be provided by the installer. This device should always be attached to a dedicated circuit with appropriate wiring and circuit protection.

LOW-VOLTAGE REMOTE SWITCHING (RECOMMENDED)

- Maximum wire length for low-voltage, 18-gauge wire is 500 feet.

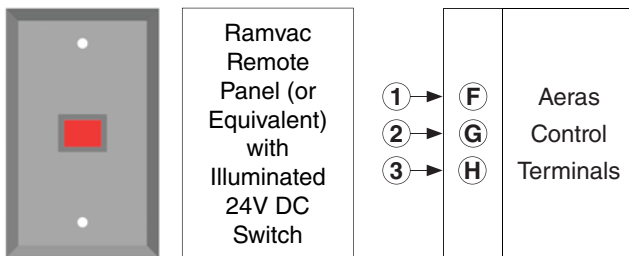

LOW-VOLTAGE REMOTE SWITCHING (ALTERNATIVE)

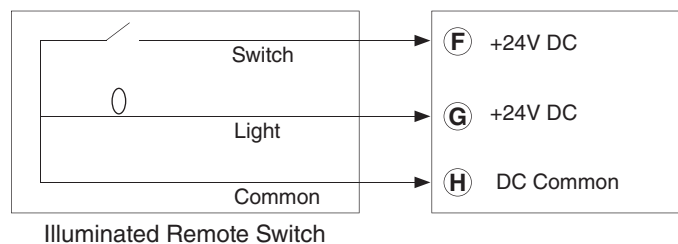
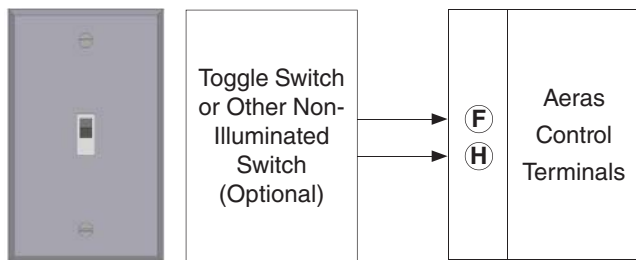

AERAS CONTROL PANEL



SPECIFICATIONS & SITE REQUIREMENTS

	<i>AERAS 10 VACUUM (RV10-2)</i>
Max Users	10
Phase	1
Horsepower (kW)	3.0 (2.2)
Voltage Rating (Min/Max)	230 (208/253)
Frequency (Hz)	60
Breaker Rating Size (Amps)	20
Full Load Amps	16.0
Fusetron Size (Recommended)	FRN 25
THHN Wire Size (AWG)	12
HR (Heat Released to Room) (BTU)	2,673
Sound Levels (dBA)	77
Weight (lbs)	395
Operating Temperature (Min/Max)	32°F / 104°F
Operating Relative Humidity Range	0-95%, No Condensing Moisture
Shipping/Transport Temperature (Min/Max)	-20°F / 165°F
Operating Atmospheric Pressure Range	63-105 kPa

PRODUCT DIMENSIONS

	<i>RV10-2</i>	<i>15-GALLON TANK</i>	<i>RV10-2 & 15-GALLON TANK STACKED</i>	<i>50-GALLON CYLINDRICAL TANK</i>
Nominal Width	26" (660 mm)	29" (737 mm)	33" (838 mm)	26" (660 mm)
Nominal Depth	22" (559 mm)	19" (483 mm)	22" (559 mm)	26" (660 mm)
Nominal Height	31" (787 mm)	24" (610 mm)	59" (1,499 mm)	62" (1,575 mm)
Drain Valve Centerline to Floor	N/A	8" (203 mm)	8" (203 mm)	5" (127 mm)

NOTE: For S-type exhaust filters, add 26" (660 mm) to height of power units.

ETL CLASSIFIED Conforms to:
ANSI/AAMI STD ES60601
Certified to:
CAN/CSA STD C22.2 NO. 60601-1



Intertek
4007136

© 2020 DENTALEZ Alabama, Inc. DENTALEZ is a registered trademark and Aeras is a trademark of DENTALEZ, Inc. Ramvac is a registered trademark of Ramvac Dental Products, Inc.

Ramvac
DENTALEZ

DENTALEZ
2500 Highway 31 South
Bay Minette, AL 36507

Phone: 866-DTE-INFO
Fax: 251-937-0461
dentalez.com

PN: 7565-066A
October, 2020